

Articulaciones para Cilindro



Horquilla I Macho



Horquilla Y Hembra



Rótula

Tipos de Montaje

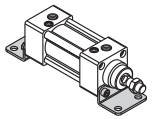

LB

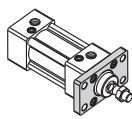

FA

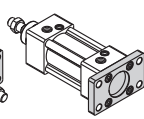

FB

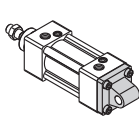

CA

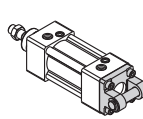

CB

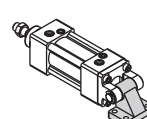

CR

Fuerza de Trabajo

$$F = P \times A$$

Fuerza
(Empuje del Cilindro) N

=

Presión de Aire
MPa

x

Área de Cilindro
mm²

Unidad: Newton(N)

Ø Cilindro (mm)	Ø Vástago (mm)	Tipo de Accionamiento	Área de Presión (mm ²)	Presión de Trabajo (MPa)									
				0.1	0.2	0.3	0.4	0.5	0.6	0.7	0.8	0.9	
125	32	Doble Efecto	Avance	12272	1227.2	2454.4	3681.6	4908.8	6136.0	7363.2	8590.4	9817.6	11044.8
		Retorno	11468	1146.8	2293.6	3440.4	4587.2	5734.0	6880.8	8027.6	9174.4	10321.2	
160	40	Doble Efecto	Avance	20106	2010.6	4021.2	6031.8	8042.4	10053.0	12063.6	14074.2	16084.8	18095.4
		Retorno	18849	1884.9	3769.8	5654.7	7539.6	9424.5	11309.4	13194.3	15079.2	16964.1	
200	40	Doble Efecto	Avance	31416	3141.6	6283.2	9424.8	12566.4	15708.0	18849.6	21991.2	25132.8	28274.4
		Retorno	30157	3015.7	6031.4	9047.1	12062.8	15078.5	18094.2	21109.9	24125.6	27141.3	
250	50	Doble Efecto	Avance	49086	4908.6	9817.2	14725.8	19634.4	24543.0	29451.6	34360.2	39268.8	44177.4
		Retorno	47123	4712.3	9424.6	14136.9	19045.5	23757.8	28470.1	33182.4	37894.7	42607.0	



Simbología

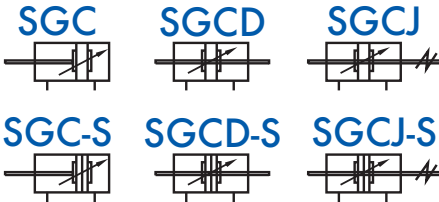

Especificaciones SGC

Ø Cilindro (mm)	125	160	200	250
Tipo de Accionamiento	Doble Efecto			
Fluido	Aire (filtrado a 40 µm)			
Tipo de Montaje	SGC	Básico: FA FB CA CB CR LB TC FTC TCM1 TCM2		
	SGCD SGCJ	Básico: FA LB TC FTC TCM1 TCM2		
Presión de Trabajo	0.15 - 1.0 MPa (22 - 145 psi) (1.5 - 10.0 bar)			
Presión de Prueba	1.5 MPa (215 psi) (15 bar)			
Temperatura °C	-20 a 70			
Velocidad mm/s	30 - 500			
Tolerancia de Carrera	0 - 250 ^{+1.0} 251 - 1000 ^{+1.5} 1001 - 1500 ^{+2.0}			
Tipo de Amortiguación	Amortiguación Variable			
Carrera de amortiguación ajustable	40	50	60	
Tamaño de Puerto	1/2"	3/4"	1"	
TPU Sellos Normal -5 a 80 °C				
NBR Sellos Viton Maximo 180 °C (Recomendado Hasta 120 °C)				

Cómo Ordenar

SGC 125 x 50 S □
 SGCD 125 x 50 S □
 SGCJ 125 x 50 - 20 S □

① ② ③ ④ ⑤ ⑥

① Modelo	② Diámetro	③ Carrera	④ Ajuste de Carrera	⑤ Imán	⑥ Opciones
SGC:Doble Efecto	125	Tomar referencia de tabla Límites de Carrera	SGC:Vacio	Vacio: Sin Imán	Vacio: TPU
SGCD: Doble Vástgo	160		SGCD: Vacio	S: Con Imán	HT: Alta Temperatura
SGCJ: Carrera Ajustable	200		SGCJ:		SR: Rosca especial
	260		10		SSR: Vástgo de Acero Inoxidable
			20		EXV: Extensión de vástgo
			30		EXC: Extensión de cuerda
			40		AG: Anti Giro
			50		TC: Trunion
			75		
			100		

Material Vástago	
Acero al Carbón 1045	20 micras de cromo
Acero Inoxidable 304	20 micras de cromo

Tipo de Montaje		
SGC:	Vacio	
	LB	
	FA	
	FB	
	CA	
	CB	
	CR	
SGCD SGCJ	Vacio	
	LB	
	FA	
	FTC	
	TC	

Límites de Carrera

Ø Cilindro (mm)	Carrera Estándar (mm)																				Máxima Carrera Estándar	Máxima Carrera	
	25	50	75	80	100	125	150	160	175	200	250	300	350	400	450	500	600	700	800	900			1000
125	25	50	75	80	100	125	150	160	175	200	250	300	350	400	450	500	600	700	800	900	1000	1500	1800
160	25	50	75	80	100	125	150	160	175	200	250	300	350	400	450	500	600	700	800	900	1000	1500	2000
200	25	50	75	80	100	125	150	160	175	200	250	300	350	400	450	500	600	700	800	900	1000	1500	2000
250	25	50	75	80	100	125	150	160	175	200	250	300	350	400	450	500	600	700	800	900	1000	1500	2000

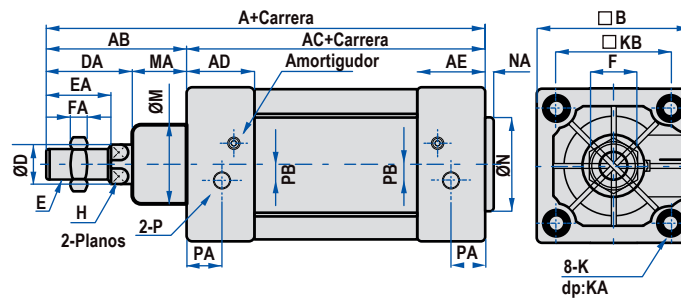

Dimensiones SGC

Ø Cilindro (mm)	A	AB	AC	AD	AE	B	D	DA	E	EA	F	FA	H	K	KA	KB	M	MA	N	NA	P	PA	PB
125	279	119	160	46	46	140	32	74	M27x2.0	54	41	13.5	27	M12	31	110	60	45	60	4	1/2"	23	14
160	332	152	180	50	50	180	40	94	M36x2.0	72	55	18	36	M16	30	140	65	58	65	4	3/4"	25	15
200	347	167	180	50	50	220	40	100	M36x2.0	72	55	18	36	M16	30	175	75	67	75	5	3/4"	25	15
250	389	189	200	58	58	282	50	111	M42x2.0	84	65	21	46	M20	35	220	90	78	90	8	1"	31	22

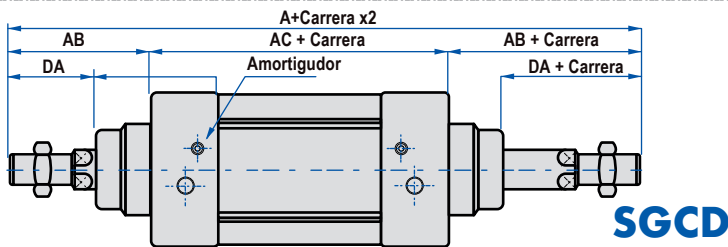

SGCD

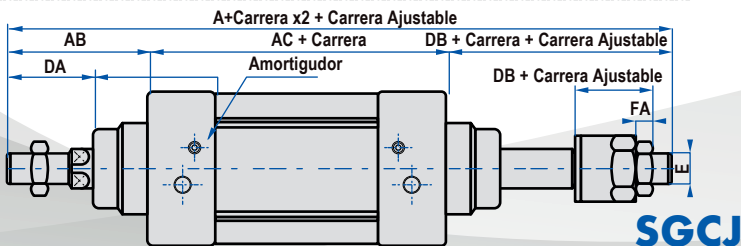

SGCJ

Dimensiones SGCD Doble Vástago SGCJ Ajuste de Carrera

Ø Cilindro (mm)	A		AB	AC	DA	DB	E	FA
	Modelo	SGCD						
125	398	366.5	119	160	74	42.5	M27X2.0	13.5
160	484	458	152	180	94	68	M36X2.0	18
200	514	482	167	180	100	68	M36X2.0	18
250	578	547	189	200	111	80	M42X2.0	21

Montajes

Códigos de Accesorios Montajes

LB

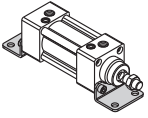

FA

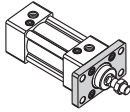

FB

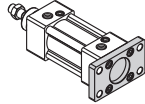

CA

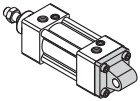

CB

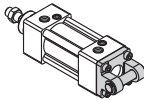

CR

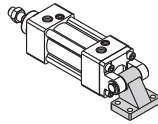

Ø Cilindro (mm)	Accesorios de Montaje				
	LB	FA / FB	CA	CB	CR
125	F-SI125LB	F-SI125FA	F-SE125CA	F-SE125CB	F-SI125CR
160	F-SI160LB	F-SI160FA	F-SI160CA	F-SI160CB	F-SI160CR
200	F-SI200LB	F-SI200FA	F-SI200CA	F-SI200CB	F-SI200CR
250	F-SG250LB	F-SG250FA	F-SG250CA	F-SG250CB	

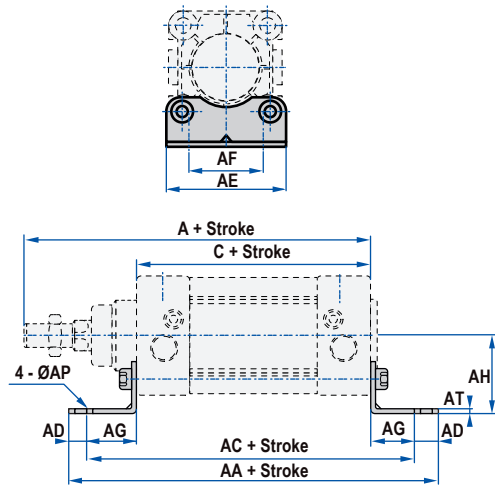

Dimensiones LB

Ø Cilindro (mm)	A	C	AA	AC	AD	AE	AF	AG	AH	AP	AT
125	279	160	290	250	20	140	90	45	90	16.5	8
160	332	180	340	300	20	180	115	60	115	18.5	8
200	347	180	380	320	30	220	135	70	135	24	9
250	389	200	410	350	30	275	165	75	165	28	19

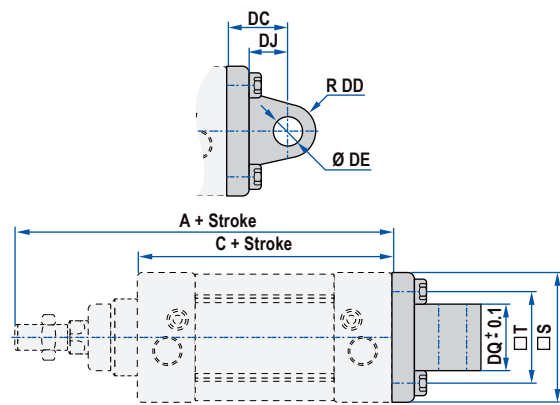

Dimensiones CA

Ø Cilindro (mm)	A	C	S	T	DC	DD	DE	DJ	DQ
125	279	160	139	110	50	22	25	33	69.7
160	332	180	180	140	55	30	30	35.5	89.7
200	347	180	220	175	60	30	30	37	89.7
250	389	200	270	220	70	35	40	46	109.5

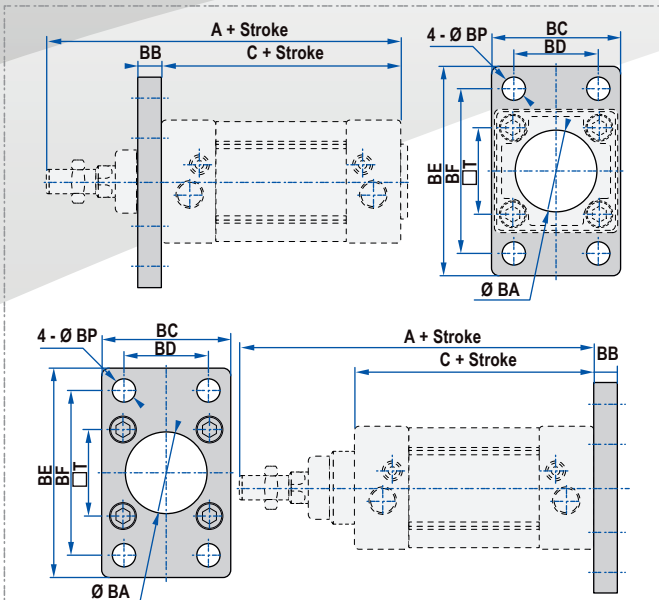

Dimensiones FA / FB

Ø Cilindro (mm)	A	C	BA	BB	BC	BD	BE	BF	BP	T
125	279	160	60.5	20	139	90	218	180	16.5	110
160	332	180	65.5	20	180	115	280	230	18.5	140
200	347	180	75.5	25	220	135	320	270	24	175
250	389	200	90.5	25	267	165	376	330	26	220

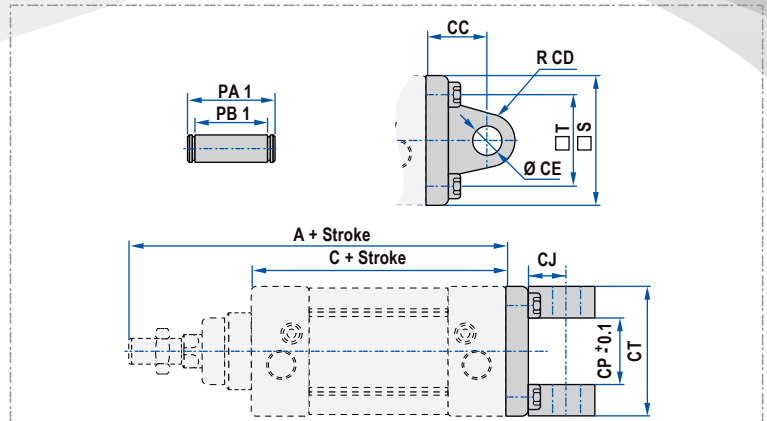

Dimensiones CB

Ø Cilindro (mm)	A	C	CC	CD	CE	CJ	CP	CT	PA1	PB1	S	T
125	279	160	50	21.5	25	31	70	130	139	130.5	134	110
160	332	180	55	30	30	35.5	90	170	181	170.5	180	140
200	347	180	60	30	30	36	90	170	181	170.5	220	175
250	389	200	70	35	40	46	110.3	200	230	208	270	220

Dimensiones CR

Ø Cilindro (mm)	A	AA	B	C	CC	CD	CJ	D	E	F	G	H	I	K	L
125	279	90	70	160	25	134	29	70	60	88	20	94	122	13.5	20
160	332	115	90	180	30	171	25.5	97	88	126	25	118	156	13.5	20
200	347	135	90	180	30	185	31	105	90	130	30	122	162	18	26

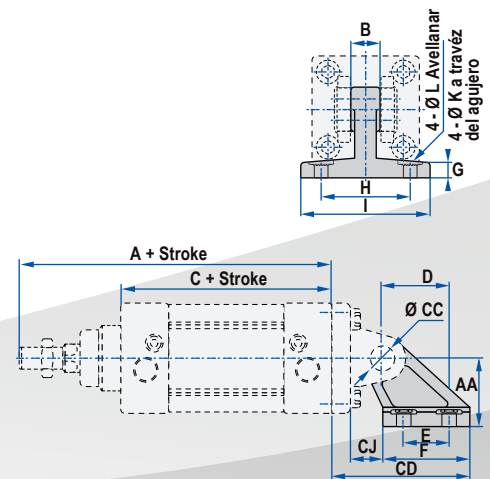

Articulaciones

Códigos de Accesorios Articulaciones para Cilindros



Horquilla I Macho



Horquilla Y Hembra



Junta Flotante



Rótula

Ø Cilindro (mm)	Horquillas		Sensor CMSG	Switch DMSG(S)
	I	Y		
125	F-M27x200I	F-M27x200Y		
160	F-M36x200I	F-M36x200Y	CMSG	DMSG(S)
200	F-M36x200I	F-M36x200Y		
250	F-M42x200I	F-M42x200Y		

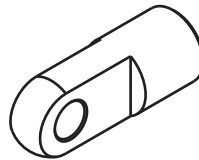

Horquilla I Macho

Cómo Ordenar

① Código Accesorio	② Rosca de Tornillo	③ Paso de Rosca	④ Código
F	M27	125: 1.25mm	I: Horquilla I Macho
M27 x 150 I	M36	150: 1.5mm	
	M42	200: 2.0mm	

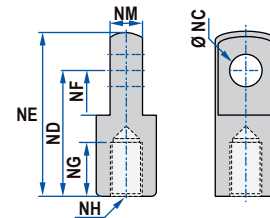

Dimensiones

Item	NC	ND	NE	NF	NG	NH	NM
F-M27x200I	30	110	139	51	45	M27x2.0	30
F-M36x200I	35	144	181	65	55	M36x2.0	35
F-M42x200I	40	168	211	85	62	M42x2.0	40

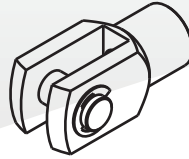

Horquilla Hembra Y

Cómo Ordenar

① Código Accesorio	② Rosca de Tornillo	③ Paso de Rosca	④ Código
	M27	125: 1.25mm	Y: Horquilla Y Hembra
	M36	150: 1.5mm	
	M42	200: 2.0mm	

F M16 x 150 Y

Dimensiones

Item	E	G	H	I
F-M10x125Y	M10x1.25	25	10	10

Item	NA	NC	ND	NP	NQ
F-M27x200Y	54	30	110	55	139
F-M36x200Y	70	35	144	73	179
F-M42x200Y	85	40	168	86	211

Item	NM	NH	PA	PB
F-M27x200Y	30	M27x2.0	64.2	54.8
F-M36x200Y	35	M36x2.0	80.2	70.8
F-M42x200Y	40.3	M42x2.0	115	93

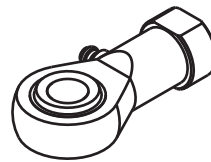
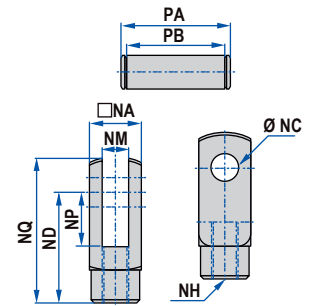

Rótula U

Cómo Ordenar

① Código Accesorio	② Rosca de Tornillo	③ Paso de Rosca	④ Código
	M10	125: 1.25mm	U: Rótula
	M12	125: 1.25mm	
	M16	150: 1.5mm	
	M20	150: 1.5mm	
	M27	200: 2.0mm	

F M10 x 125 U

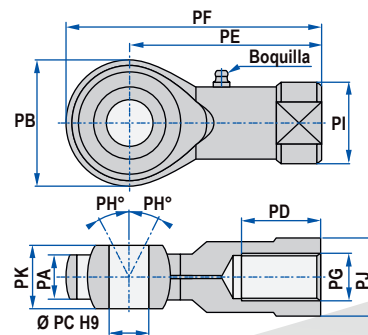

Dimensiones

Item	PA	PB	PC	PD	PE	PF	PG	PH	PI	PJ	PK
F-M27x200U	25	70	30	51	110	145	M27x2.0	15	50	41	37
F-M36x200U	27.5	80	35	56	125	165	M36x2.0	15	57.5	50	43

ROMIHN[®]
Automation Technology

Strokmatic[®]
Automation Technology

www.romihn.com.mx

222 940 0313

contactcenter@romihn.com.mx

Ubicaciones

 Puebla	222 531 2925
 CDMX	553 408 1489
 Guadalajara	332 870 3192
 Querétaro	442 668 1414
 Tijuana	664 275 4360
 Santa Catarina	812 254 5561
 Aguascalientes	449 205 4364