

# Preparation unit——GA Series

## GAFC Series F.R.L. combination

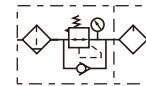

Reflux valve is attached



No reflux valve is attached

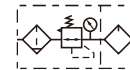

### Ordering code

**GAFC300**  **10**  **S**  **W T K**

1
2
3
4
5
6
7
8
9

① Model	② Material of bowl	③ Port size	④ Drain type	
GAFC200:GA200 Series FR.L unit	Blank: PC N: Nylon C: Metal	06: 1/8" 08: 1/4"	Blank: Semi-auto drain A: Automatic drain	
GAFC300:GA300 Series FR.L unit		08: 1/4" 10: 3/8" 15: 1/2"		
GAFC400:GA400 Series FR.L unit		10: 3/8" 15: 1/2"		
GAFC600:GA600 Series FR.L unit		20: 3/4" 25: 1"		
C: Metal				
⑤ Type code	⑥ Pressure gauge	⑦ Filtering grade	⑧ Thread type	⑨ Reflux valve
S: Standard L: Lower pressure [Note1]	Blank: Circular with clip N: No pressure gauge	Blank: 40μm W: 5μm	T: NPT (Scale: bar/psi)	Blank: Without reflux valve K: with reflux valve [Note2]

[Note1] The maximum work pressure of lower pressure type is 58psi(0.4MPa);

[Note2] Please refer to page 141 for details of reflux valve.

### Product feature

1. Quick and reliable mounting clamps makes it convenient to install and use.
2. The performance of pressure adjustment is reliable with high precision.
3. The efficiency of eliminating moisture and solid grain is high.
4. Two drain types are available: semi-auto drain and automatic drain.
5. Three material of bowl are available: PC, Nylon and metal.

## GAFC Series F.R.L. combination

### Specification

Model	GAFC20006	GAFC20008	GAFC30008	GAFC30010	GAFC30015	GAFC40010	GAFC40015	GAFC60020	GAFC60025	
Fluid	Air									
Port size [Note1]	1/8"	1/4"	1/4"	3/8"	1/2"	3/8"	1/2"	3/4"	1"	
Filtering grade	40 μm or 5 μm									
Pressure range	20~130psi(0.15~0.9MPa)									
Max. pressure	145psi(1.0MPa)									
Proof pressure	215psi(1.5MPa)									
Temperature range	-5~70°C(Unfreeze)									
Capacity of drain bowl	25CC		60CC			100CC		205CC		
Capacity of oil bowl	36CC		98CC			185CC		410CC		
Recommended lubricant	ISO VG 32or equivalent									
Weight	590g		1020g			1810g		3430g		
Constitute	Filter-Regulator	GAFR20006	GAFR20008	GAFR30008	GAFR30010	GAFR30015	GAFR40010	GAFR40015	GAFR60020	GAFR60025
	Lubricator	GAL20006	GAL20008	GAL30008	GAL30010	GAL30015	GAL40010	GAL40015	GAL60020	GAL60025

[Note1] NPT thread is available.

### Pressure chart

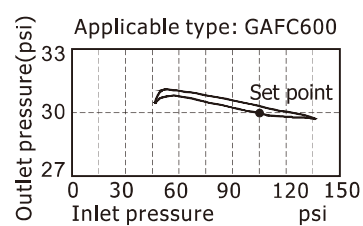
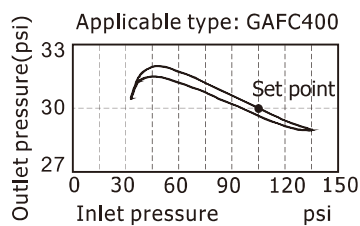
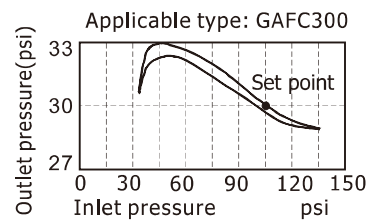
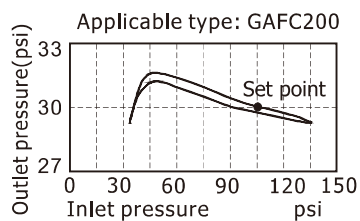

## GAFC Series F.R.L. combination

### Flow chart

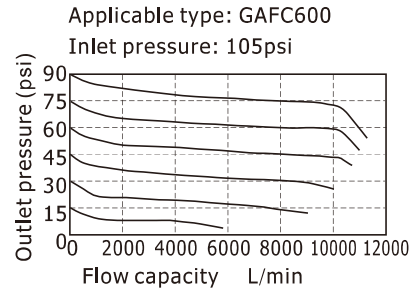
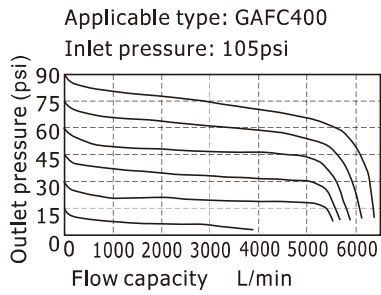
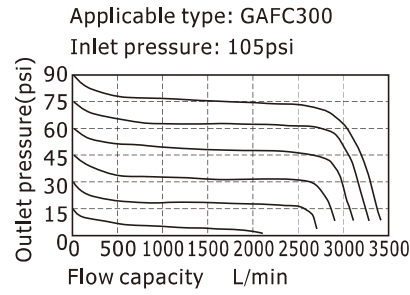
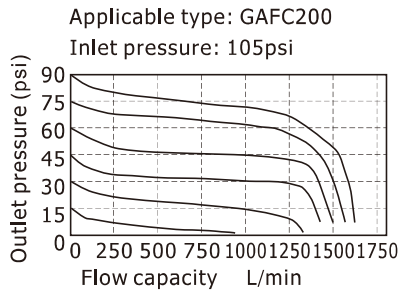

### Dimensions

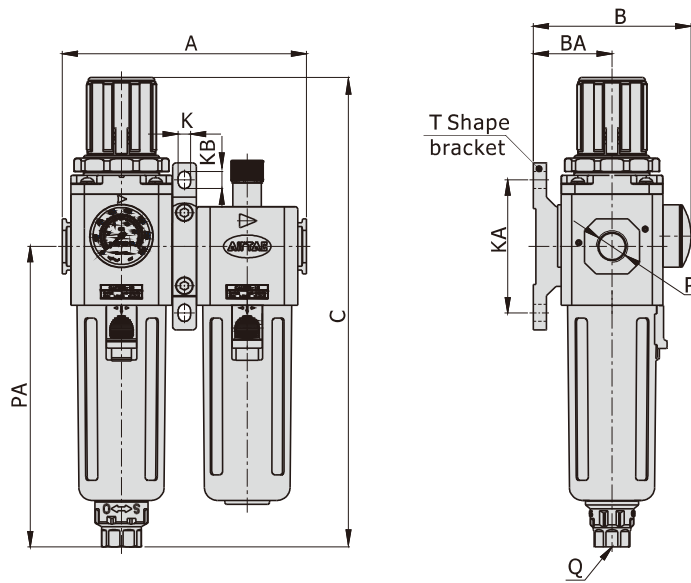

[Unit: mm]

Model\Item	A	B	BA	C	K	KA	KB	P	PA	Q
GAFC200-06	107.5	69	30	192.5	5.5	50	8.5	1/8"	120	M5X0.8
GAFC200-08	107.5	69	30	192.5	5.5	50	8.5	1/4"	120	M5X0.8
GAFC300-08	128.5	83	41.5	247	6.5	70	9	1/4"	158	G1/4
GAFC300-10	128.5	83	41.5	247	6.5	70	9	3/8"	158	G1/4
GAFC300-15	128.5	83	41.5	247	6.5	70	9	1/2"	158	G1/4
GAFC400-10	164	99	50	285.5	8.5	80	12	3/8"	177.5	G1/4
GAFC400-15	164	99	50	285.5	8.5	80	12	1/2"	177.5	G1/4
GAFC600-20	208	128	70	336.5	11	100	16	3/4"	205	G1/4
GAFC600-25	208	128	70	336.5	11	100	16	1"	205	G1/4