

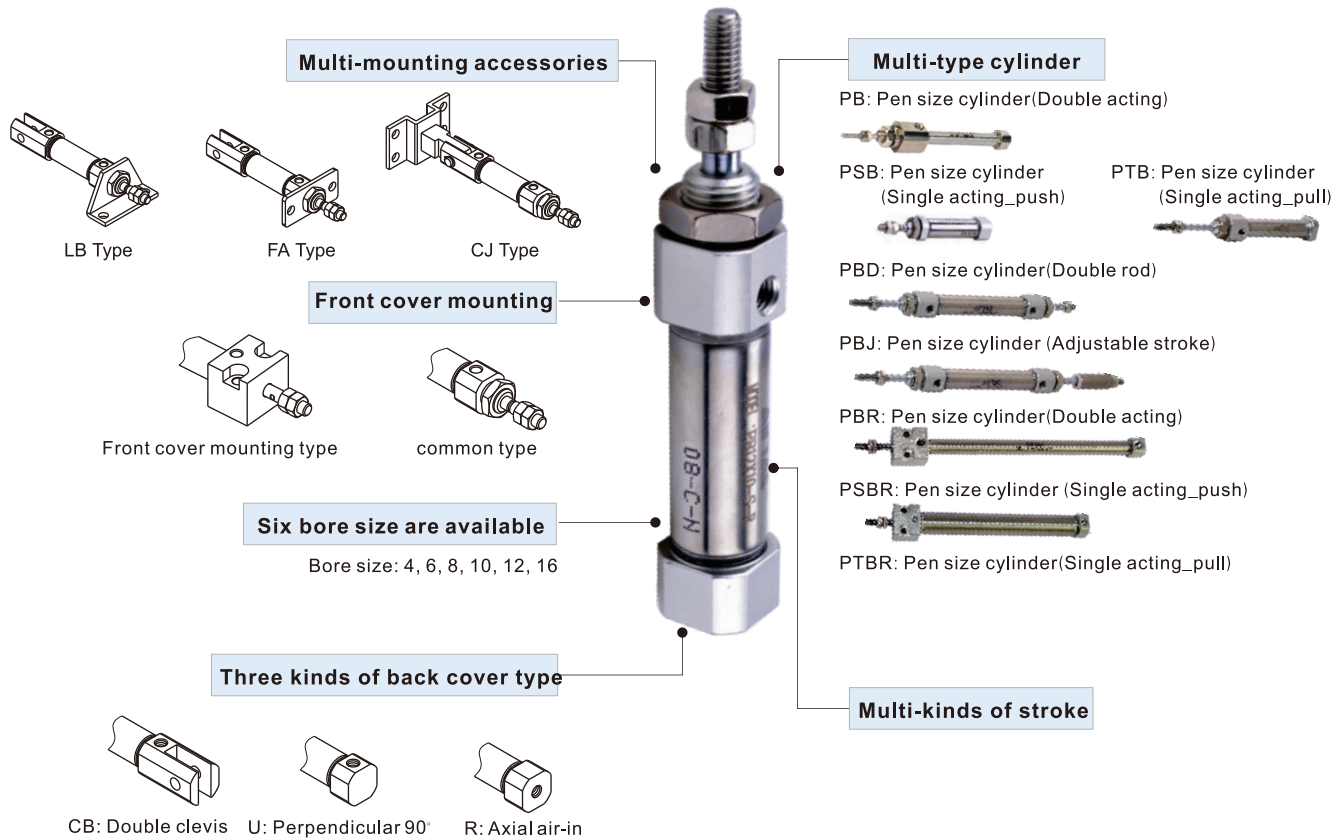

Pen size cylinder—PB Series

Compendium of PB Series



Criteria for selection: Cylinder thrust

Unit: Newton(N)

Bore size	Rod size	Acting type	Pressure area(mm ²)	Operating pressure(MPa)						
				0.1	0.2	0.3	0.4	0.5	0.6	0.7
4	2	Single acting_Push side	12.6	-	0.3	1.6	2.8	4.1	5.3	6.6
		Double acting Push side	12.6	1.3	2.5	3.8	5.0	6.3	7.6	8.8
		Double acting Pull side	9.4	0.9	1.9	2.8	3.8	4.7	5.6	6.6
6	3	Single acting Push side	28.3	-	2.2	5.0	7.8	10.6	13.5	16.3
		Single acting Pull side	21.2	-	0.7	2.9	5.0	7.1	9.2	11.3
		Double acting Push side	28.3	2.8	5.7	8.5	11.3	14.2	17.0	19.8
8	4	Double acting Pull side	21.2	2.1	4.2	6.4	8.5	10.6	12.7	14.8
		Single acting Push side	50.3	-	3.6	8.6	13.6	18.7	23.7	28.7
		Single acting Pull side	37.7	-	1.0	4.8	8.6	12.4	16.1	19.9
10	4	Double acting Push side	50.3	5.0	10.1	15.1	20.1	25.2	30.2	35.2
		Double acting Pull side	37.7	3.8	7.5	11.3	15.1	18.9	22.6	26.4
		Single acting Push side	78.5	-	6.2	14.1	21.9	29.8	37.6	45.5
12	5	Single acting Pull side	65.9	-	3.7	10.3	16.9	23.5	30.1	36.7
		Double acting Push side	78.5	7.9	15.7	23.6	31.4	39.3	47.1	55.0
		Double acting Pull side	65.9	6.6	13.2	19.8	26.4	33.0	39.5	46.2
16	5	Single acting Push side	113.0	-	9.0	20.3	31.6	42.9	54.2	65.5
		Single acting Pull side	93.4	-	5.1	14.4	23.8	33.1	42.4	51.8
		Double acting Push side	113.0	11.3	22.6	33.9	45.2	56.5	67.8	79.1
16	5	Double acting Pull side	93.4	9.3	18.7	28.0	37.4	46.7	56.0	65.4
		Single acting Push side	201.0	-	14.5	34.6	54.7	74.8	94.9	115.0
		Single acting Pull side	181.3	-	10.6	28.7	46.8	65.0	83.1	101.2
16	5	Double acting Push side	201.0	20.1	40.2	60.3	80.4	100.5	120.6	140.7
		Double acting Pull side	181.3	18.1	36.3	54.4	72.5	90.7	108.8	126.9

Installation and application



1. When load changes in the work, the cylinder with abundant output capacity shall be selected.
2. Relative cylinder with high temperature resistance or corrosion resistance shall be chosen under the condition of high temperature or corrosion.
3. Necessary protection measure shall be taken in the environment with higher humidity, much dust or water drops, oil dust and welding dregs.
4. Dirty substances in the pipe must be eliminated before cylinder is connected with pipeline to prevent the entrance of particles into the cylinder.
5. The medium used by cylinder shall be filtered to 40 μm or below.
6. Anti-freezing measure shall be adopted under low temperature environment to prevent moisture freezing.
7. The load of the cylinder with the diameter of Φ4 needs to be coaxial with the cylinder to avoid side load, otherwise, piston rod will be bent and deformed and damage the thread at the end of the rod. Single-acting type can not be added in return.
8. If the cylinder is dismantled and stored for a long time, Please to conduct anti-rust treatment to the surface. Anti-dust caps shall be added in air inlet and outlet ports. The front and back cover can not be dismantled, which shall be especially noticed.



Pen size cylinder

PB Series



Symbol

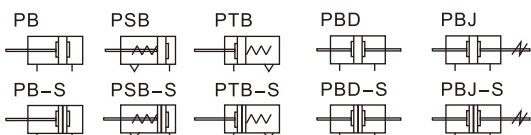

Product feature

1. JIS standard is implemented.
2. It belongs to mini cylinder that has compact structure, small volume and light weight.
3. The guide precision of piston rod is high and no additional lubricant is needed.
4. PB4 and PB6 can only be front mounted. PB10, PB12 and PB16 has the flexibility of both front and rear mount.
5. Piston rod stainless steel barrel make the cylinder adapt general corrosive working environment.
6. There are cylinders and accessories with several specifications for installation for your choice.
7. It has small cylinder diameter and quick reaction, suitable for the working environment with higher frequency.

Specification

Bore size(mm)		4	6	10	12	16
Acting type		Double acting	Single acting_Push	Double acting、Single acting		
Fluid		Air(to be filtered by 40 μm filter element)				
Operating pressure	Double acting	0.2~0.7MPa(28~100psi)(2.0~7.0bar)		0.15~0.7MPa(22~100psi)(1.5~7.0bar)		
	Single acting	0.3~0.7MPa(36~100psi)(3.0~7.0bar)		0.2~0.7MPa(28~100psi)(2.0~7.0bar)		
Proof pressure		1.2MPa(175psi)(12bar)				
Temperature °C		-20~70				
Speed range mm/s		50~500		50~800		
Stroke tolerance		+0.5		0~150 ^{+1.0}		>150 ^{+1.5}
Cushion type		No cushion			Bumper	
Port size		Tube			M5 × 0.8	

Add) Refer to P353 for detail of sensor switch.

Stroke

Bore size (mm)	Standard stroke (mm)										Max.std stroke	Max. stroke							
	4	5	10	15	20	25	30	40	50	60									
PB	6	10	15	20	25	30	40	50	60		60	60							
	10	10	15	20	25	30	40	50	60	75	80	100	125	150	160	175	200	200	
	12	10	15	20	25	30	40	50	60	75	80	100	125	150	160	175	200	200	
	16	10	15	20	25	30	40	50	60	75	80	100	125	150	160	175	200	250	300
PBD	6	5	10	15	20	25	30	40	50		50	—							
PBD	10	10	15	20	25	30	40	50	60	75	80	100	100	—					
	12	10	15	20	25	30	40	50	60	75	80	100	125	150	160	175	200	200	—
PBJ	16	10	15	20	25	30	40	50	60	75	80	100	125	150	160	175	200	200	—
	PSB	4	5	10	15	20							—	—					
PSB	6	5	10	15	20	25	30	40	50	60		—	—						
	10	5	10	15	20	25	30	40	50	60		—	—						
PTB	12	5	10	15	20	25	30	40	50	60		—	—						
	16	5	10	15	20	25	30	40	50	60		—	—						

[Note] Consult us for non-standard stroke.

Ordering code

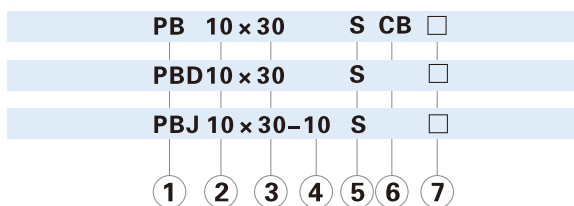

① Model	② Bore size	③ Stroke	④ Adjustable stroke	⑤ Magnet	⑥ Back cover			⑦ Mounting type [Note 1]				
PB: Pen size cylinder (Double acting) PSB: Pen size cylinder (Single acting_push)	4	Refer to stroke table for details	No this code	Blank: Without magnet S: With magnet	Model	Back cover	Bore size	Model	Mounting type			
	6					CB: Double clevis				Φ10~Φ16	PB PSB PTB	Blank: No accessories FA: FA type LB: LB type CJ: CJ type
	10					U: Perpendicular 90°				Φ10~Φ16		
	12					R: Axial air-in				Φ6~Φ16		
16	CB: Double clevis				Φ10~Φ16							
PTB: Pen size cylinder (Single acting_pull) PBD: Pen size cylinder (Double rod)	6							PTB	R: Axial air-in	Φ6~Φ16		
	10											
PBJ: Pen size cylinder (Adjustable stroke)	12					10 20 30		PBD PBJ	No this code	—	PBD PBJ	Blank: No accessories FA: FA type LB: LB type
	16					40 50 75 100						

[Note 1] Please refer to page 75 for accessory parts.

Pen size cylinder

PB Series

Inner structure and material of major parts

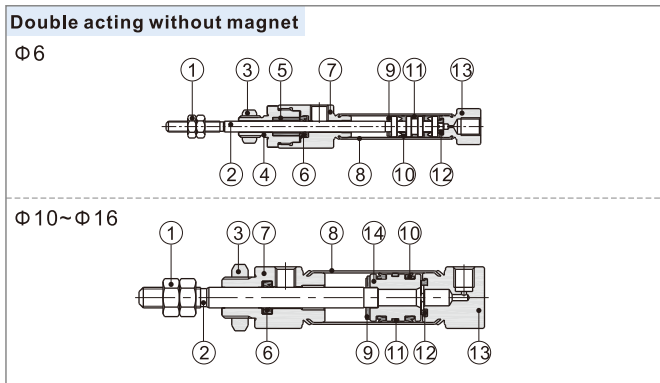

NO.	Item	Material
1	Rod nut	Carbon steel
2	Piston rod	SUS304
3	Front cover nut	Carbon steel
4	Packing retainer	Brass(Φ4)\Aluminum alloy(Others)
5	Bushing	Wear resistant material
6	Front cover O-ring	NBR
7	Front cover	Brass(Φ4)\Aluminum alloy(Others)
8	Barrel	Bronze(Φ4)\SUS304(Others)
9	Bumper	TPU
10	Piston seal	NBR
11	Wear ring	Wear resistant material
12	Bumper	TPU
13	Back cover	Brass(Φ4)\Aluminum alloy(Others)

Dimensions

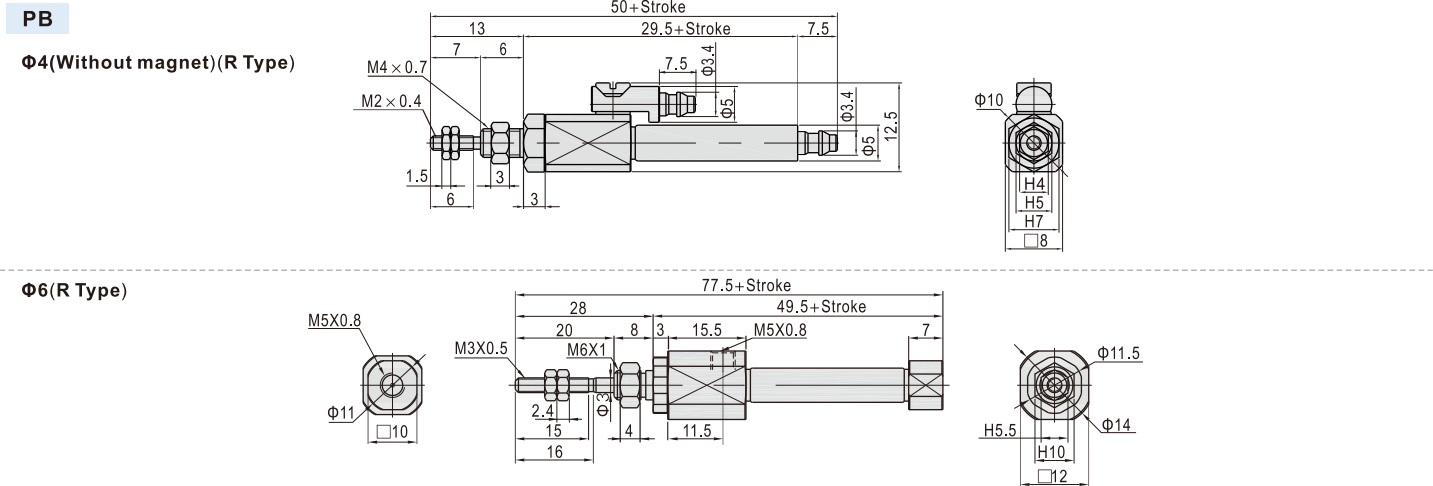

Note) Only axial air intake type of back cover is available for Φ4, Φ6mm bore size.

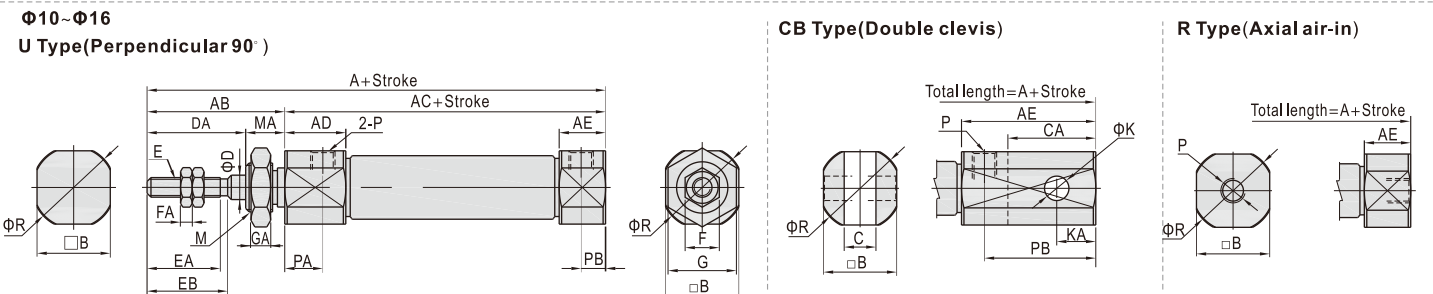

Bore size\Item	A			AB	AC	AD	AE		B	C	CA	D	DA	E	EA	EB	F	FA	G	GA	K	KA	M	MA	P	PA	PB		
	U	CB	R				U/R	CB																			U	CB	R
10	74	87	74	28	46	11.5	9.5	22.5	12	3.3	13	4	20	M4×0.7	15	16.5	7	3	11	4	3.3	5	M8×1.0	8	M5×0.8	7.5	5	18	14
12	74	92	74	28	46	11.5	9.5	27.5	15	6.6	18	5	20	M5×0.8	15	16.5	8	4	14	4	5	8	M10×1.0	8	M5×0.8	7.5	5	23	17
16	76	94	76	28	48	12	9.5	27.5	18	6.6	18	5	20	M5×0.8	15	16.5	8	4	14	4	5	8	M10×1.0	8	M5×0.8	7.5	5	23	20

Remark: The dimensions of magnet type cylinder are the same as non-magnet type cylinder.

Pen size cylinder

PB Series

PSB $\Phi 4$ (Without magnet)(R Type)

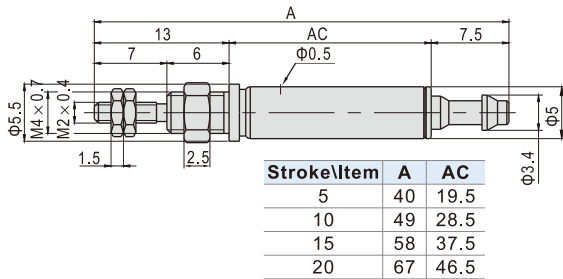

$\Phi 6$ (R Type)

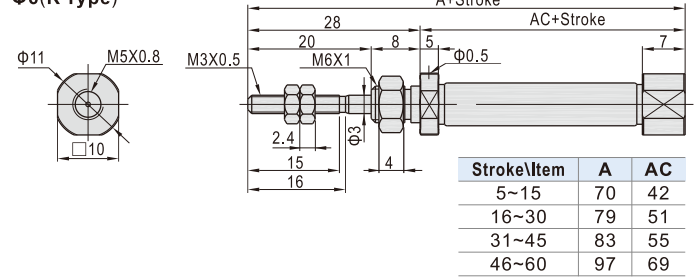

Note) Only axial air intake type of back cover is available for $\Phi 4$, $\Phi 6$ mm bore size.

$\Phi 10$ ~ $\Phi 16$

U Type(Perpendicular 90°)

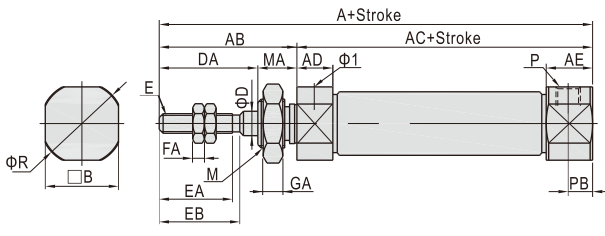

CB Type(Double clevis)

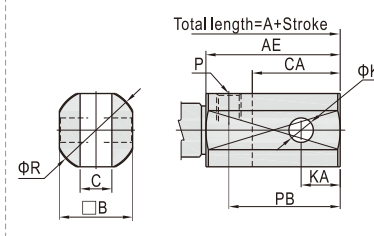

R Type(Axial air-in)

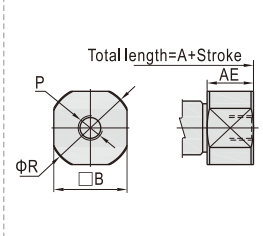

Bore size\Item	Back cover	A												AB	AC				AD	AE			
		U				CB				R					U/R	CB	B	C					
Stroke		5~15	16~30	31~45	46~60	5~15	16~30	31~45	46~60	5~15	16~30	31~45	46~60		5~15	16~30	31~45	46~60		-	-	B	C
10		73.5	81	93	105	86.5	94	106	118	73.5	81	93	105	28	45.5	53	65	77	5	9.5	22.5	12	3.3
12		73.5	81	93	105	91.5	99	111	123	73.5	81	93	105	28	45.5	53	65	77	5	9.5	27.5	15	6.6
16		74.5	83	95	107	92.5	101	113	125	74.5	83	95	107	28	46.5	55	67	79	5	9.5	27.5	18	6.6

Bore size\Item	Back cover	CA	D	DA	E	EA	EB	F	FA	G	GA	K	KA	M	MA	P	PB		R
		U	CB																
10		13	4	20	M4×0.7	15	16.5	7	3	11	4	3.3	5	M8×1.0	8	M5×0.8	5	18	14
12		18	5	20	M5×0.8	15	16.5	8	4	14	4	5	8	M10×1.0	8	M5×0.8	5	23	17
16		18	5	20	M5×0.8	15	16.5	8	4	14	4	5	8	M10×1.0	8	M5×0.8	5	23	20

Remark: The dimensions of magnet type cylinder are the same as non-magnet type cylinder.

PTB $\Phi 6$ (R Type)

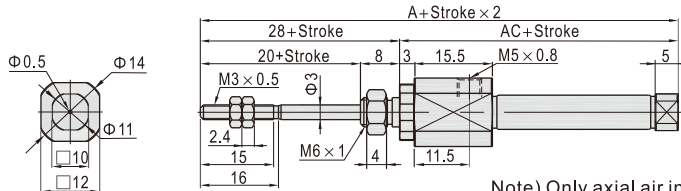

Note) Only axial air intake type of back cover is available for $\Phi 6$ mm bore size.

$\Phi 10$ ~ $\Phi 16$

R Type(Axial air-in)

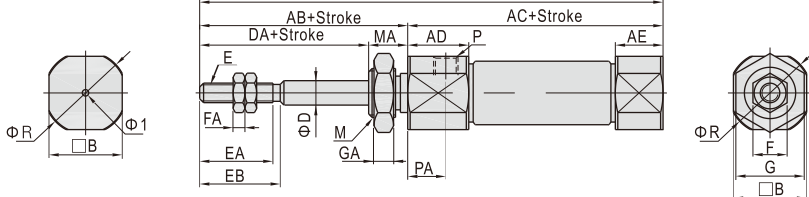

CB Type(Double clevis)

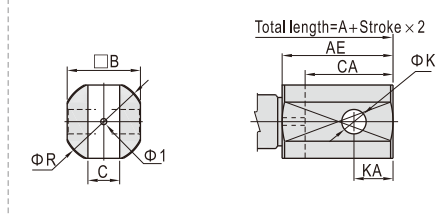

Bore size\Item	Back cover	A												AB	AC				AD
		R				CB				-									
Stroke		5~15	16~30	31~45	46~60	5~15	16~30	31~45	46~60	5~15	16~30	31~45	46~60		5~15	16~30	31~45	46~60	
10		76.5	84	96	108	89.5	97	109	121	28	48.5	56	68	80	11.5				
12		76.5	84	96	108	94.5	102	114	126	28	48.5	56	68	80	11.5				
16		77.5	86	98	110	95.5	104	116	128	28	49.5	58	70	82	12				

Bore size\Item	Back cover	AE		B	C	CA	D	DA	E	EA	EB	F	FA	G	GA	K	KA	M	MA	P	PA	R
		R	CB																			
10		5	18	12	3.3	13	4	20	M4×0.7	15	16.5	7	3	11	4	3.3	5	M8×1.0	8	M5×0.8	7.5	14
12		5	23	15	6.6	18	5	20	M5×0.8	15	16.5	8	4	14	4	5	8	M10×1.0	8	M5×0.8	7.5	17
16		5	23	18	6.6	18	5	20	M5×0.8	15	16.5	8	4	14	4	5	8	M10×1.0	8	M5×0.8	7.5	20

Note) $\Phi 10$ ~ $\Phi 16$ bore sized don't have perpendicular(90°) air-in.

Remark: The dimensions of magnet type cylinder are the same as non-magnet type cylinder.

Pen size cylinder

PB Series

PBD

Φ6

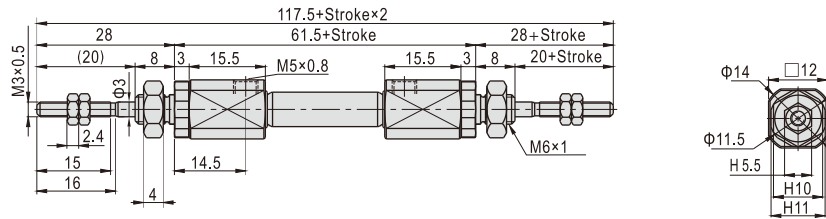

Φ10~Φ16

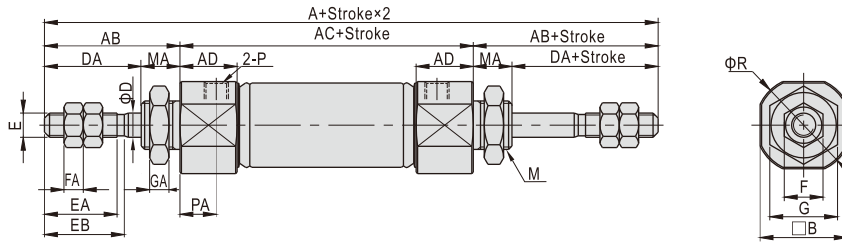

PBJ

Φ10~Φ16

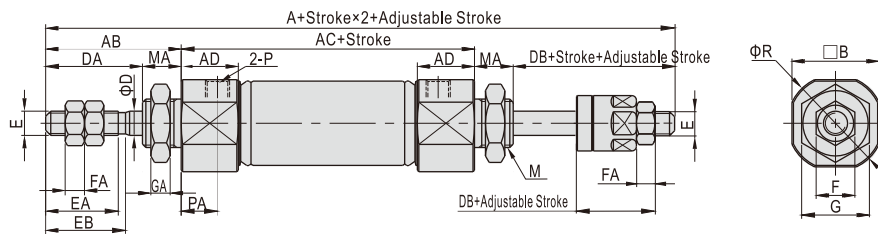

Bore size\Item	A		AB	AC	AD	B	D	DA	DB	E	EA	EB	F	FA	G	GA	M	MA	P	PA
	Model	PBD																		
10	104	99	28	48	11.5	12	4	20	15	M4×0.7	15	16.5	7	3	11	4	M8×1.0	8	M5×0.8	7.5
12	104	101	28	48	11.5	15	5	20	17	M5×0.8	15	16.5	8	4	14	4	M10×1.0	8	M5×0.8	7.5
16	107	104	28	51	12	18	5	20	17	M5×0.8	15	16.5	8	4	14	4	M10×1.0	8	M5×0.8	7.5

Remark: The dimensions of magnet type cylinder are the same as non-magnet type cylinder.

Pen size cylinder

PBR Series

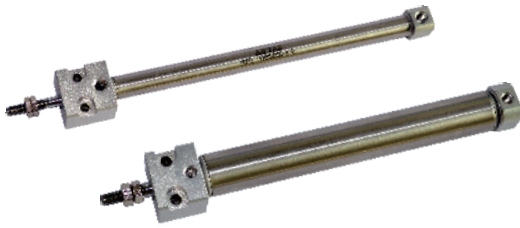

Symbol

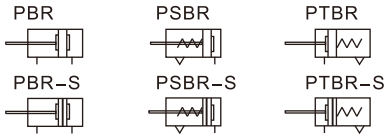

Product feature

1. JIS standard is implemented.
2. It belongs to mini cylinder that has compact structure, small volume and light weight.
3. The guide precision of piston rod is high and no additional lubricant is needed.
4. Screw holes are designed for mounting directly at the front cover without any accessories.
5. Piston rod stainless steel barrel make the cylinder adapt general corrosive working environment.
6. It has small cylinder diameter and quick reaction, suitable for the working environment with higher frequency.

Specification

Bore size(mm)	6	8	10	12	16
Acting type	Double acting, Single acting				
Fluid	Air(to be filtered by 40 μm filter element)				
Operating pressure	0.15~0.7MPa(22~100psi)(1.5~7.0bar)				
	0.2~0.7MPa(28~100psi)(2.0~7.0bar)				
Proof pressure	1.2MPa(175psi)(12bar)				
Temperature °C	-20~70				
Speed range mm/s	50~800				
Stroke tolerance	0~150 ^{+1.0} ₀ >150 ^{+1.5} ₀				
Cushion type	Bumper				
Port size	M5 × 0.8				

Add) Refer to P353 for detail of sensor switch.

Stroke

Bore size (mm)	Standard stroke (mm)	Max.std stroke	Max. stroke	
PBR	6	10 15 20 25 30 40 50 60	60	60
	8	10 15 20 25 30 40 50 60 75 80 100 125 150	150	200
	10	10 15 20 25 30 40 50 60 75 80 100 125 150 160 175 200	200	200
	12	10 15 20 25 30 40 50 60 75 80 100 125 150 160 175 200	200	300
	16	10 15 20 25 30 40 50 60 75 80 100 125 150 160 175 200 250 300	300	300
PSBR PTBR	6	5 10 15 20 25 30 40 50 60	-	-
	8	5 10 15 20 25 30 40 50 60	-	-
	10	5 10 15 20 25 30 40 50 60	-	-
	12	5 10 15 20 25 30 40 50 60 75	-	-
	16	5 10 15 20 25 30 40 50 60 75 100	-	-

[Note] Consult us for non-standard stroke.

Ordering code

PBR 16 x 30 S U



① Model	② Bore size	③ Stroke	④ Magnet	⑤ Back cover		
PBR: Pen size cylinder(Double acting) PSBR: Pen size cylinder(Single acting_push) PTBR: Pen size cylinder(Single acting_pull)	6	Refer to stroke table for details	Blank: Without magnet S: With magne	Model	Back cover	Bore size
	8			PBR	U: Perpendicular 90°	Φ8~Φ16
	10			PSBR	R: Axial air-in	Φ6~Φ16
	12			PTBR	R: Axial air-in	Φ6~Φ16
16						

Mounting type

Top bolt mounting

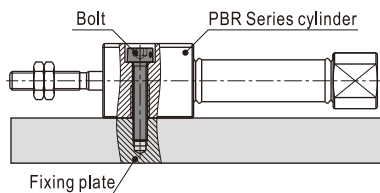

Bottom bolt mounting

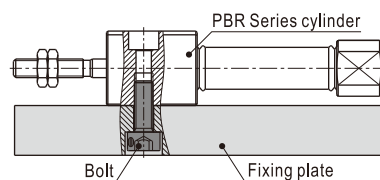

Note: Use an applicable bolt to mount upward from the bottom.

PBR Series

Inner structure and material of major parts

Double acting with magnet

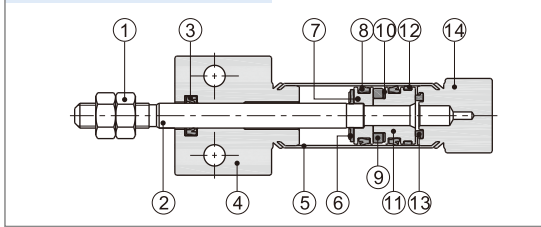

NO.	Item	Material	NO.	Item	Material
1	Rod nut	Carbon steel	8	Piston seal	NBR
2	Piston rod	SUS304	9	Magnet	Sintered metal(Neodymium-iron-boron)
3	Front cover O-ring	NBR	10	Magnet washer	NBR
4	Front cover	Aluminum alloy	11	Magnet holder	Aluminum alloy
5	Barrel	SUS316L	12	Wear ring	Wear resistant material
6	Bumper	TPU	13	Bumper	TPU
7	Piston	SUS303/Aluminum alloy	14	Back cover	Aluminum alloy

Dimensions

PBR

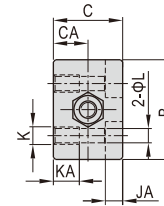
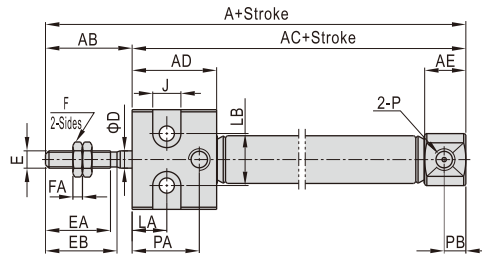
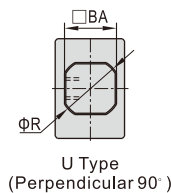
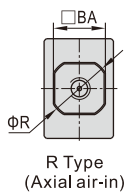

Bore size\Item	A	AB	AC	AD	AE	B	BA	C	CA	D	E	EA	EB	F	FA	J	JA	K	KA	L	LA	LB	P	PA	PB	R
6	70	20	50	19	7	17	10	14	7	3	M3×0.5	15	16	5.5	2.4	6.5	4	M4×0.7	7	3.3	8	10	M5×0.8	14	-	11
8	74	20	54	19.5	9.5	19	12	16	8	4	M4×0.7	15	16.5	7	3	6.5	4	M4×0.7	7	3.3	8	12	M5×0.8	15	5	14
10	74	20	54	19.5	9.5	19	12	16	8	4	M4×0.7	15	16.5	7	3	6.5	4	M4×0.7	7	3.3	8	12	M5×0.8	15.5	5	14
12	74	20	54	19.5	9.5	24	15	20	10	5	M5×0.8	15	16.5	8	4	8	5	M5×0.8	8	4.3	8	16	M5×0.8	15.5	5	17
16	76	20	56	20	9.5	24	18	20	10	6	M5×0.8	15	16.5	8	4	8	5	M5×0.8	8	4.3	8	16	M5×0.8	15.5	5	20

Remark: The dimensions of magnet type cylinder are the same as non-magnet type cylinder. Only axial air intake type of back cover is available for Φ6mm bore size.

PSBR

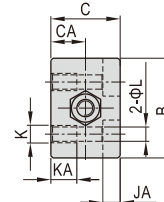
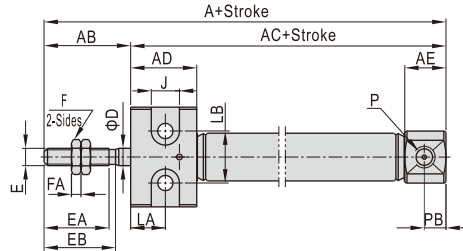
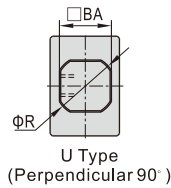
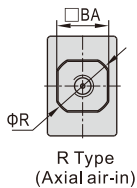

PTBR

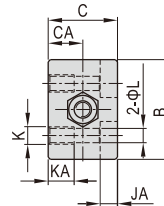
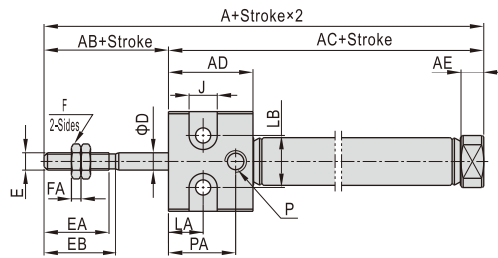
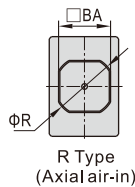

Bore size\Item	A												AC											
	PSBR						PTBR						PSBR						PTBR					
Model	5-15	16-30	31-45	46-60	61-75	76-100	5-15	16-30	31-45	46-60	61-75	76-100	5-15	16-30	31-45	46-60	61-75	76-100	5-15	16-30	31-45	46-60	61-75	76-100
6	70	79	83	97	-	-	74.5	83.5	87.5	101.5	-	-	50	59	63	77	-	-	54.5	63.5	67.5	81.5	-	-
8	76.5	82.5	93.5	101.5	-	-	78.5	84.5	95.5	103.5	-	-	56.5	62.5	73.5	81.5	-	-	58.5	64.5	75.5	83.5	-	-
10	73.5	81	93	105	-	-	76.5	84	96	108	-	-	53.5	61	73	85	-	-	56.5	64	76	88	-	-
12	73.5	81	93	105	111.5	-	76.5	84	96	108	114.5	-	53.5	61	73	85	91.5	-	56.5	64	76	88	94.5	-
16	74.5	83	95	107	113	119	77.5	86	98	110	116	122	54.5	63	75	87	93	99	57.5	66	78	90	96	102

Bore size\Item	AD		AB	AE		B	BA	C	CA	D	E	EA	EB	F	FA	J	JA	K	KA	L	LA	LB	P	PA	PB	R
	Model	PSBR		PTBR	PSBR																					
6	13	19	20	7	5	17	10	14	7	3	M3×0.5	15	16	5.5	2.4	6.5	4	M4×0.7	7	3.3	8	10	M5×0.8	14	-	11
8	13	19.5	20	9.5	5	19	12	16	8	4	M4×0.7	15	16.5	7	3	6.5	4	M4×0.7	7	3.3	8	12	M5×0.8	15	5	14
10	13	19.5	20	9.5	5	19	12	16	8	4	M4×0.7	15	16.5	7	3	6.5	4	M4×0.7	7	3.3	8	12	M5×0.8	15.5	5	14
12	13	19.5	20	9.5	5	24	15	20	10	5	M5×0.8	15	16.5	8	4	8	5	M5×0.8	8	4.3	8	16	M5×0.8	15.5	5	17
16	13	20	20	9.5	5	24	18	20	10	6	M5×0.8	15	16.5	8	4	8	5	M5×0.8	8	4.3	8	16	M5×0.8	15.5	5	20

Remark: The dimensions of magnet type cylinder are the same as non-magnet type cylinder. Only axial air intake type of back cover is available for Φ6mm bore size.

Pen size cylinder

PB Series—Accessories

List for ordering code of accessories

Accessories Bore size	Mounting accessories			Knuckle				Sensor switch	
	LB	FA	CJ	I	Y	F	U	CMSG	DMSG(S)
4	-	-	-	-	-	-	-	-	-
6	F-PB6LB	F-PB6FA	-	F-PB6I	F-PB6Y	F-M3X040F	-	CMSG	DMSG(S)
10	F-PB10LB	F-PB10FA	F-PB10CJ	F-PB10I	F-PB10Y	F-M4X070F	F-M4X070U		
12	F-PB12LB	F-PB12FA	F-PB12CJ	F-PB12I	F-PB12Y	F-M5X080F	F-M5X080U		
16			F-PB16CJ						

Accessory selection

Accessories Cylinder model		Mounting accessories			Knuckle				Sensor switch	
		LB	FA	CJ	I	Y	U [1]	F	CMSG	DMSG(S)
PB	Standard	●	●	●	●	●	●	●	×	×
	With magnet	●	●	●	●	●	●	●	●	●
PSB	Standard	●	●	●	●	●	●	●	×	×
	With magnet	●	●	●	●	●	●	●	●	●
PBD	Standard	●	●	×	●	●	●	●	×	×
PBJ	With magnet	●	●	×	●	●	●	●	●	●

Material of accessories

Accessories Bore size	Mounting accessories			Knuckle			
	LB	FA	CJ	I	Y	F	U
4~16	△	△	△	□	□	□	□

△—SPCC; □—Carbon steel;

[Note 1] Please refer to P349~352 for knuckle detail.

Dimensions

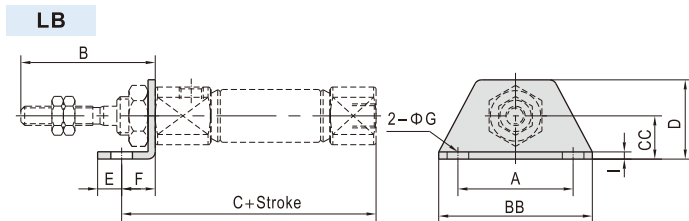

Bore size\Item	A	B	BB	C	CC	D	E	F	G	I
6	24	28	32	56.5	9	16.5	5	7	4.5	1.5
10	24	28	32	53	9	16.5	5	7	4.5	2
12	33	28	42	55	14	25	6	9	5.5	2.5
16	33	28	42	57	14	25	6	9	5.5	2.5

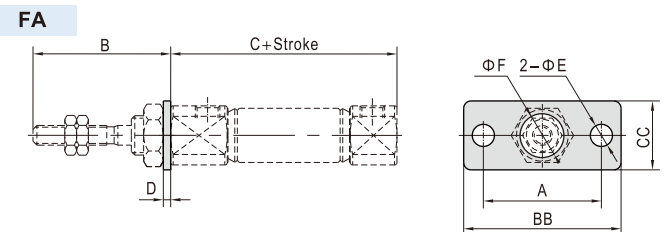

Bore size\Item	A	B	BB	C	CC	D	E	F
6	24	28	32	49.5	14	1.5	4.5	6.3
10	24	28	32	46	14	2	4.5	8.2
12	33	28	42	46	20	3	5.5	10.2
16	33	28	42	48	20	3	5.5	10.2

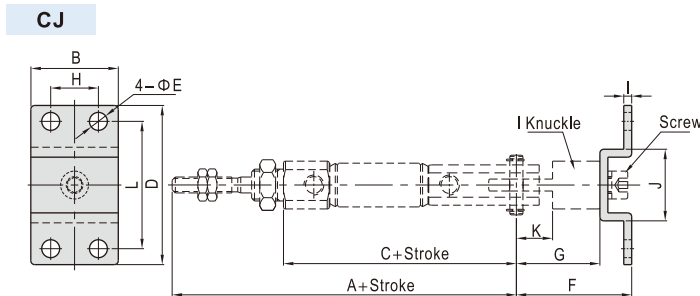

Bore size\Item	A	B	C	D	E	F	G	H	I	J	K	L
10	82	22	54	40	4.5	29	21	12	2	18	9.1	32
12	84	28	56	48	5.5	35	25	16	2.5	20.4	14.1	38
16	86	28	58	48	5.5	35	25	16	2.5	20.4	14.1	38

[Note] CJ type accessories includes I knuckle and PIN. It need to be matched with I knuckle and with relevant PIN.

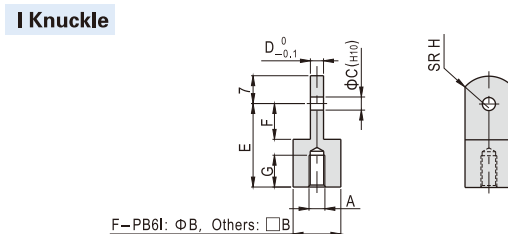

Bore size\Item	A	B	C	D	E	F	G	H
F-PB6I	M3×0.5	6	3	3	12	5	5	5
F-PB10I	M4×0.7	12	3.3	3	21	9.1	7.5	8
F-PB12I	M5×0.8	12	5	6.3	25	14.1	7.5	12

Y Knuckle

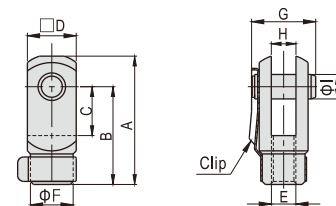

Bore size\Item	A	B	C	D	E	F	G	H	I
F-PB6Y	15.5	12	5	6	M3×0.5	6	9	3	3
F-PB10Y	28	21	10.2	12	M4×0.7	10	15.5	3.2	3.3
F-PB12Y	28	21	10.2	12	M5×0.8	10	15.5	6.5	5